

MD800 | 33.9L | 800 kW

INDUSTRIAL DIESEL GENERATOR SET

EPA Certified Stationary Emergency

GENERAC® | **INDUSTRIAL
POWER**

Standby Power Rating

800 kW, 1,000 kVA, 60 Hz

Prime Power Rating*

720 kW, 900 kVA, 60 Hz



*Assembled in the USA using domestic and foreign parts

*EPA Certified Prime ratings are not available in the US or its Territories

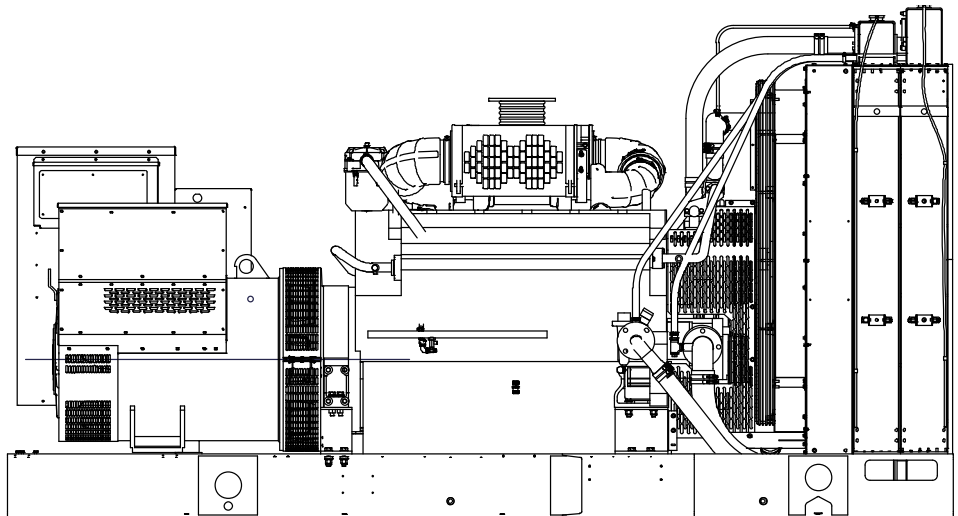

Image used for illustration purposes only

Codes and Standards

Not all codes and standards apply to all configurations. Contact factory for details.



UL2200, UL6200, UL1236, UL489, UL142



CSA C22.2, ULC S601



BS5514 and DIN 6271



SAE J1349



NFPA 37, 70, 99, 110



NEC700, 701, 702, 708



ISO 3046, 7637, 8528, 9001



NEMA ICS10, MG1, 250, ICS6, AB1



ANSI C62.41

Powering Ahead

For over 60 years, Generac has provided innovative design and superior manufacturing.

Generac ensures superior quality by designing and manufacturing most of its generator components, including alternators, enclosures and base tanks, control systems and communications software.

Generac gensets utilize a wide variety of options, configurations and arrangements, allowing us to meet the standby power needs of practically every application.

Generac searched globally to ensure the most reliable engines power our generators. We choose only engines that have already been proven in heavy-duty industrial applications under adverse conditions.

Generac is committed to ensuring our customers' service support continues after their generator purchase.

STANDARD FEATURES

ENGINE SYSTEM

- Oil Drain Extension
- Air Cleaner
- Level 1 Fan and Belt Guards (Open Set Only)
- Stainless Steel Flexible Exhaust Connection
- Factory Filled Oil and Coolant
- Radiator Duct Adapter (Open Set Only)

FUEL SYSTEM

- Flexible Fuel Lines (When Tank is Selected)
- Primary and Secondary Fuel Filter

COOLING SYSTEM

- Closed Coolant Recovery System
- UV/Ozone Resistant Hoses
- Factory-Installed Radiator
- Radiator Drain Extension
- 50/50 Ethylene Glycol Antifreeze

ELECTRICAL SYSTEM

- Battery Charging Alternator
- Battery Cables
- Battery Tray
- Rubber-Booted Engine Electrical Connections
- Solenoid Activated Starter Motor

ALTERNATOR SYSTEM

- Class H Insulation Material
- 2/3 Pitch
- Skewed Stator
- Permanent Magnet Excitation
- Sealed Bearing
- Full Load Capacity Alternator
- Main Line Circuit Breaker

GENERATOR SET

- Separation of Circuits - High/Low Voltage
- Separation of Circuits - Multiple Breakers
- Standard Factory Testing
- 2 Year Limited Warranty (Standby Rated Units)
- 1 Year Limited Warranty (Prime Rated Units)

ENCLOSURE (If Selected)

- Structural Steel Sub-Base
- Sub-Base Lifting Eyes
- Enamel Finish
- Zinc Plated Fasteners
- Zinc Plated Cast Aluminum Keylock Door Handles
- Heavy Duty Stainless Steel Hinges with Removable Brass Pins
- Modular Construction

FUEL TANKS (If Selected)

- UL 142/ULC S601
- Double Wall
- Vents
- Factory Pressure Tested (2 psi)
- Rupture Basin Alarm
- Fuel Level
- Check Valve In Supply and Return Lines
- Stainless Steel Hardware
- Fuel Line Hose
- Fuel Line Hose and Separator
- Electronic Fuel Level
- Secondary Fuel Filter

CONTROL SYSTEM

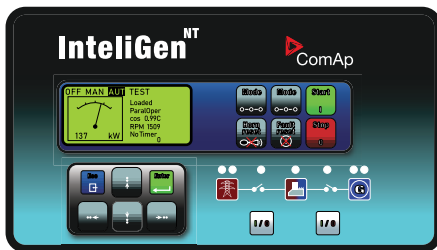

IntelliGen® NT Display

Program Functions

- Programmable Crank Limiter
- 7-Day Programmable Exerciser
- Special Applications Programmable Logic Controller
- RS-232/485 Communications
- 2-Wire Start Capability
- Date/Time Fault History (Event Log)
- Isochronous Governor Control
- Waterproof/Sealed Connectors
- Audible Alarms and Shutdowns
- Not in Auto (Flashing Light)

- Auto/Off/Manual Switch
- Customizable Alarms, Warnings, and Events
- Modbus® Protocol
- Predictive Maintenance Algorithm
- Sealed Boards
- Password Parameter Adjustment Protection
- Single Point Ground
- 16 Channel Remote Trending
- 0.2 msec High Speed Remote Trending
- Alarm Information Automatically Annunciated on the Display

Full System Status Display

- Power Output (kW)
- Power Factor
- kW Hours, Total, and Last Run
- Real/Reactive/Apparent Power
- All Phase AC Voltage
- All Phase Currents
- Oil Pressure
- Coolant Temperature
- Coolant Level
- Engine Speed
- Battery Voltage
- Frequency

Alarms and Warnings

- Oil Pressure
- Coolant Temperature
- Coolant Level
- Engine Overspeed
- Battery Voltage
- Alarms and Warnings Time and Date Stamped
- Snap Shots of Key Operation Parameters During Alarms and Warnings
- Alarms and Warnings Spelled Out (No Alarm Codes)

CONFIGURABLE OPTIONS

ENGINE SYSTEM

- 50° Ambient Cooling System
- Hospital Grade Silencers
- CCV (Closed Crankcase Ventilation)

ELECTRICAL SYSTEM

- 10A UL Listed Battery Charger
- 20A UL Listed Battery Charger
- Battery Warmer

ALTERNATOR SYSTEM

- Alternator Upsizing
- Anti-Condensation Heater

CIRCUIT BREAKER OPTIONS

- Shunt Trip and Auxiliary Contact
- Electronic Trip Breakers

GENERATOR SET

- Spring Isolators (Standard/Seismic)

ENCLOSURE

- Weather Protected Enclosure
- Level 1 Sound Attenuation
- Level 2 Sound Attenuation
- Steel Enclosure
- Aluminum Enclosure
- AC Electrical Lighting Package (ELP)
- Up to 200 MPH Wind Load Rating (Contact Factory for Availability)
- Louvers with Gravity Dampers
- Enclosure Heaters

WARRANTY (Standby Gensets Only)

- 2 Year Extended Limited Warranty
- 5 Year Limited Warranty
- 5 Year Extended Limited Warranty
- 7 Year Extended Limited Warranty
- 10 Year Extended Limited Warranty

CONTROL SYSTEM

- NFPA 110 Level I and II (Programmable) 15- LED Remote Annunciator
- Remote Relay Assembly (8 or 16)
- Shipped Loose Remote E-Stop - Surface Mount
- Generator Control Panel Mounted E-Stop
- Remote Communication - InternetBridge NT
- 10A Engine Run Relay
- Low Coolant Level Indication
- 90% High Fuel Alarm

FUEL TANKS (Size on Last Page)

- 12 Hour Run Time
- 24 Hour Run Time

ENGINEERED OPTIONS

ENGINE SYSTEM

- Coolant Heater Ball Valves
- Oil Heater
- Fuel Cooler
- High Lift Pumps
- Heavy Duty Air Filters (Open Set Only)

ALTERNATOR SYSTEM

- 2nd Main Line Circuit Breaker
- Unit Mounted Load Banks
- Medium Voltage Alternators
- Digital Voltage Regulator

CONTROL SYSTEM

- Spare Inputs (x4) / Outputs (x4)
- Battery Disconnect Switch
- PM-SCi

GENERATOR SET

- Special Testing

ENCLOSURE

- Door Open Alarm Horn
- Level 3 Enclosure
- Custom Enclosure

FUEL TANKS

- Overfill Protection Valve
- UL2085 Tank
- Special Fuel Tanks
- External Vent Extensions
- Transfer Pumps and Controllers
- Fuel Tank Heaters

MD800 | 33.9L | 800 kW

INDUSTRIAL DIESEL GENERATOR SET

EPA Certified Stationary Emergency

APPLICATION AND ENGINEERING DATA

ENGINE SPECIFICATIONS

General

Make	Mitsubishi
Model	S12A2-Y2PTAW-2
EPA Emissions Compliance	Tier 2
EPA Emissions Reference	See Emission Data Sheet
Cylinder #	12
Type	4 Cycle
Displacement - in ³ (L)	2,071 (33.9)
Bore - in (mm)	5.91 (150)
Stroke - in (mm)	6.30 (160)
Compression Ratio	15.3:1
Intake Air Method	Turbocharged/Intercooled
Cylinder Head	4-Valve
Piston Type	Aluminum
Crankshaft Type	Dropped Forged Steel

Engine Governing

Governor	Electronic
Frequency Regulation (Steady State)	±0.25%

Lubrication System

Oil Pump Type	Gear
Oil Filter Type	Cartridge
Crankcase Capacity - qt (L)	106 (100)

Cooling System

Cooling System Type	Unit Mounted Radiator
Water Pump Type	Centrifugal
Fan Type	Pusher
Fan Speed - RPM	1,085
Fan Diameter - in (mm)	64 (1,625)

Fuel System

Fuel Type	Ultra Low Sulfur Diesel Fuel #2
Fuel Specifications	ASTM
Fuel Filtering (Microns)	10 (Final Filters)
Fuel Inject Pump	Mechanical
Fuel Pump Type	Engine Driven Gear
Injector Type	Bosch P-Type
Fuel Supply Line - in (mm)	3/4" NPT (19.0)
Fuel Return Line - in (mm)	3/4" NPT (19.0)

Engine Electrical System

System Voltage	24 VDC
Battery Charger Alternator	Standard
Battery Size	See Battery Index 0161970SBY
Battery Voltage	(2) - 12 VDC
Ground Polarity	Negative

ALTERNATOR SPECIFICATIONS

Standard Model	K0912124Y22
Poles	4
Field Type	Rotating
Insulation Class - Rotor	H
Insulation Class - Stator	H
Total Harmonic Distortion	<4%
Telephone Interference Factor (TIF)	<50

Standard Excitation	Permanent Magnet
Bearings	Single Sealed Cartridge
Coupling	Direct via Flexible Disc
Load Capacity- Standby	100%
Prototype Short Circuit Test	Yes
Voltage Regulator Type	Analog
Regulation Accuracy (Steady State)	±0.5%

MD800 | 33.9L | 800 kW

INDUSTRIAL DIESEL GENERATOR SET

EPA Certified Stationary Emergency

OPERATING DATA

POWER RATINGS

		Standby
Three-Phase 277/480 VAC @0.8pf	800 kW	Amps: 1,203
Three-Phase 346/600 VAC @0.8pf	800 kW	Amps: 962

MOTOR STARTING CAPABILITIES (skVA)

skVA vs. Voltage Dip	
277/480 VAC	30%
K0912124Y22	3,250
K1000124Y22	3,100

FUEL CONSUMPTION RATES*

Fuel Pump Lift- ft (m)	Diesel - gph (Lph)	
	Percent Load	Standby
3 (1)	25%	19.5 (73)
	50%	34.6 (131)
	75%	50.9 (193)
	100%	74.4 (282)
Total Fuel Pump Flow (Combustion + Return) - gph (Lph)		
148 (560)		

* Fuel supply installation must accommodate fuel consumption rates at 100% load.

COOLING

Cooling Rating - Jacket Water			Cooling Rating - Aftercooler		
		Standby			Standby
Coolant Flow	gpm (Lpm)	291 (1,100)	Coolant Flow	gpm (Lpm)	124 (470)
Coolant System Capacity	gal (L)	65 (246)	Coolant System Capacity	gal (L)	41 (155)
Heat Rejection to Coolant	BTU/hr (kW)	1,225,080 (359)	Heat Rejection to Coolant	BTU/hr (kW)	962,580 (282)
Inlet Air- 40°C Cooling Package	cfm (m³/min)	35,900 (1,017)			
Inlet Air- 50°C Cooling Package	cfm (m³/min)	40,100 (1,136)			
			Cooling Rating - Fuel Pump		
Maximum Additional Radiator Backpressure	in H ₂ O (kPa)	0.5 (0.12)	Heat Rejected to Fuel	BTU/hr (kW)	6,039 (1.8)

COMBUSTION AIR REQUIREMENTS

	Standby
Flow at Rated Power - cfm (m³/min)	3,107 (88)

ENGINE

		Standby
Rated Engine Speed	RPM	1,800
Horsepower at Rated kW**	hp	1,207
Piston Speed	ft/min (m/min)	1,890 (576.1)
BMEP	psi (kPa)	256 (1,765)

EXHAUST

		Standby
Exhaust Flow (Rated Output)	cfm (m³/min)	8,192 (232)
Maximum Allowable Backpressure	inHg (kPa)	1.7 (5.9)
Exhaust Temperature (Rated Output - Post Silencer)	°F (°C)	932 (500)

** Refer to "Emissions Data Sheet" for maximum bHP for EPA and SCAQMD permitting purposes.

Deration – Operational characteristics consider maximum ambient conditions. Derate factors may apply under atypical site conditions.

Please contact a Generac Power Systems Industrial Dealer for additional details. All performance ratings in accordance with ISO3046, BS5514, ISO8528, and DIN6271 standards.

Standby - See Bulletin 0187500SSB

Prime - See Bulletin 0187510SSB

DIMENSIONS AND WEIGHTS*

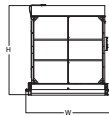
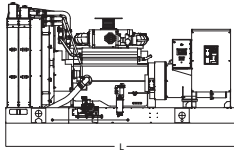

OPEN SET

Run Time - Hours	Usable Capacity - Gal (L)	L x W x H - in (mm)	Weight - lbs (kg)	
			Steel	Aluminum
No Tank	-	177.7 (4,515) x 82.6 (2,099) x 94.0 (2,389)		22,496 (10,204)
12	800 (3,029)	201.0 (5,105) x 96.0 (2,438) x 118.2 (3,002)		26,446 (11,996)
24	1,600 (6,058)	201.0 (5,105) x 96.0 (2,438) x 131.2 (3,332)		27,822 (12,620)

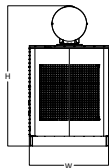
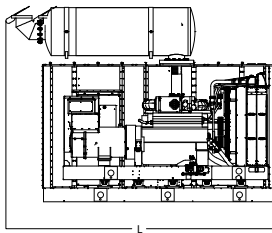

WEATHER PROTECTED ENCLOSURE

Run Time - Hours	Usable Capacity - Gal (L)	L x W x H - in (mm)	Weight - lbs (kg) Enclosure Only	
			Steel	Aluminum
No Tank	-	235.0 (5,969) x 98.0 (2,489) x 170.3 (4,326)		
12	800 (3,029)	235.0 (5,969) x 98.0 (2,489) x 187.3 (4,758)	5,553 (2,519)	4,394 (1,994)
24	1,600 (6,058)	235.0 (5,969) x 98.0 (2,489) x 200.3 (5,088)		

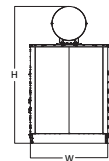
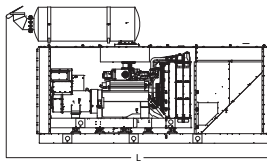

LEVEL 1 SOUND ATTENUATED ENCLOSURE

Run Time - Hours	Usable Capacity - Gal (L)	L x W x H - in (mm)	Weight - lbs (kg) Enclosure Only	
			Steel	Aluminum
No Tank	-	Contact Factory		
12	800 (3,029)	Contact Factory	8,958 (4,064)	7,799 (3,538)
24	1,600 (6,058)	Contact Factory		

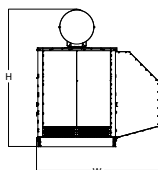
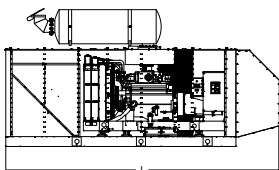

LEVEL 2 SOUND ATTENUATED ENCLOSURE

Run Time - Hours	Usable Capacity - Gal (L)	L x W x H - in (mm)	Weight - lbs (kg) Enclosure Only	
			Steel	Aluminum
No Tank	-	339.9 (8,633) x 150.0 (3,810) x 169.3 (4,299)		
12	800 (3,029)	340.0 (8,636) x 150.0 (3,810) x 169.2 (4,298)	10,137 (4,599)	6,853 (3,109)
24	1,600 (6,058)	340.0 (8,636) x 150.0 (3,810) x 178.2 (4,526)		

* All measurements and weights are approximate and for estimation purposes only.

YOUR FACTORY RECOGNIZED GENERAC INDUSTRIAL DEALER

Specification characteristics may change without notice. Please contact a Generac Power Systems Industrial Dealer for detailed installation drawings.